

MVS-5000™ Series

Machine Vision Strobe



The MVS-5000™ Machine Vision strobe from Excelitas is ideal for a variety of applications including quality assurance and motion detection.

Description

The MVS-5000™ Machine Vision strobe from Excelitas Technologies produces short duration, high intensity light pulses for machine vision applications.

The Xenon flashlamp in the MVS-5000 produces intense pulses of radiant energy covering the full spectrum from the ultraviolet (UV) to the visible (VIS) to near infrared (NIR). The spectral output of the Xenon lamp when coupled with CCD, CMOS, and CID silicon cameras freezes motion, eliminates blur, and enhances image quality with high intensity and short duration pulses.

The MVS-5000 is a DC powered unit. The linear Xenon flashlamp is packaged in a metal enclosure with a fan for cooling. The strobe incorporates a reflector for maximum intensity and a diffuser window for even illumination of the target area. Input power and signal level cable connections are made through a 9 pin connector mounted on the back of the unit.

Key Features

- Flash rates to 60 HZ
- Long life Xenon flashlamp
- Uniform illumination
- Compact / Lightweight
- Low cost
- Optically isolated trigger input
- Reduced EMI
- CE Certified

Applications

- Quality assurance
- Contamination protection
- Motion detection
- Part inspection

MVS-5000 Series

Machine Vision Strobe

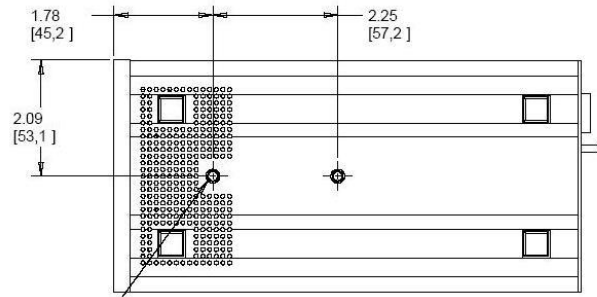
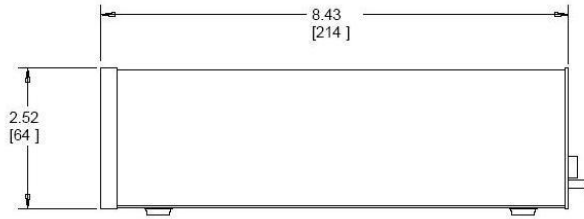
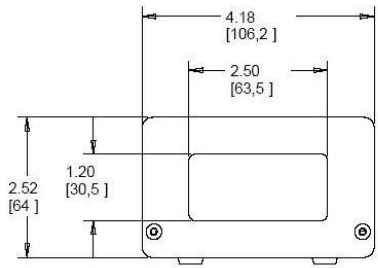

2X M5 MOUNTING HOLE
.24 (6 MM) MAXIMUM
SCREW PENETRATION

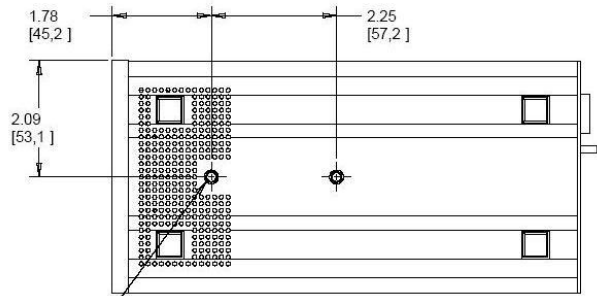
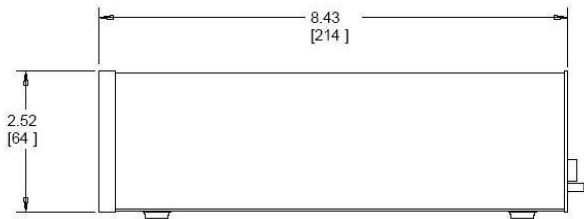
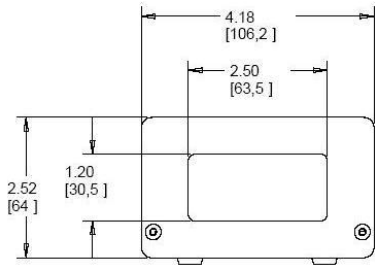

2X M5 MOUNTING HOLE
.24 (6 MM) MAXIMUM
SCREW PENETRATION

MVS-5000 Series

Machine Vision Strobe

TABLE 1 Optical Specifications

MVS 5770-01	Narrow Beam	Wide Beam
Maximum flash rate (2)	1 Hz	1 Hz
Optical output at 1m	1mJ/cm ²	0.4mJ
Vertical beam spread (3)	8°	25°
Horizontal beam spread (3)	75°	75°
Spectral bandwidth (4)	780 – 1100 nm	780 – > 1100nm
Pulse duration (5)	200 µsec	200 µsec
Flash to flash stability	±10%	±10%

TABLE 2 Electrical Specifications

MVS 5770-01	Wide Beam	Narrow Beam
Input voltage	90 – 230 VAC (±10%), 50/60 Hz	90 – 230 VAC (±10%), 50/60 Hz
Input energy per flash (2)	50 J	50 J
Average power	50 W	50 W
Discharge capacitor	100 µF	100 µF
Input current (rms)	< 3 A	< 3 A
Flashlamp voltage (6)	600 – 1000 VDC	600 – 1000 VDC
Remote intensity control	4 – 6.7 VDC (Vlamp = 150 x Vref)	4 – 6.7 VDC (Vlamp = 150 x Vref)
Trigger input	+5V / 25mA, 10 – 100 µsec pulse into 4N36 opto-isolator with internal 150Ω resistor	+5V / 25mA, 10 – 100 µsec pulse into 4N36 opto-isolator with internal 150Ω resistor

TABLE 3 Environmental Specifications

Operating temperature	-10 - +110°F (-23 - +43°C)
Storage temperature	-40 - +194°F (-40 - +90°C)

Note 1: All values are nominal and subject to change without notice.
 Note 2: Higher flash rates are available at lower flash energies.
 Note 3: Measured at 50% points of peak intensity.
 Note 4: Bandwidth depends on filter used; typical Xenon spectrum is 250-1100 + nm.
 Note 5: Measured at 1/3 of peak.
 Note 6: Factory set at 1000 VDC.

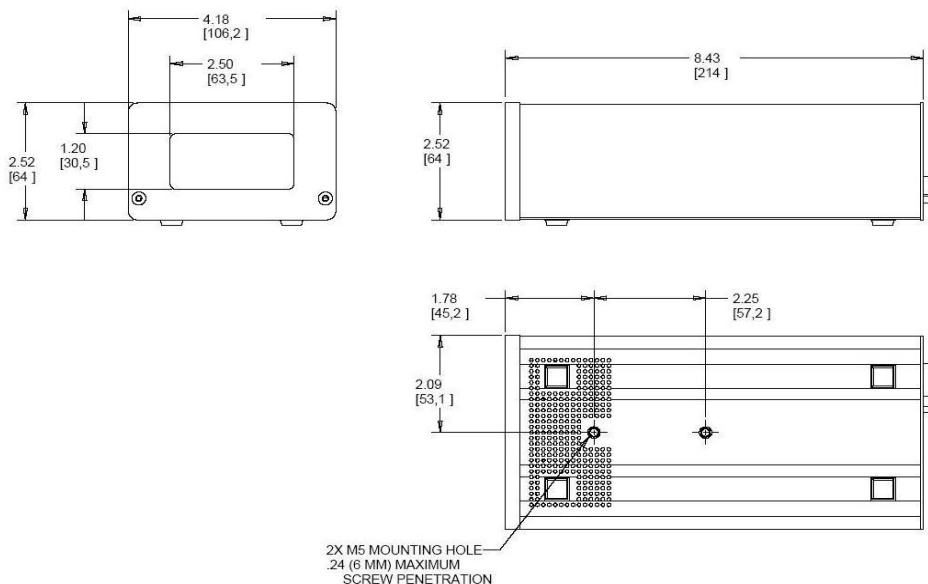

About Excelitas Technologies

Excelitas Technologies is a global technology leader focused on delivering innovative, customized solutions to meet the lighting, detection, energetic, frequency standards and high-reliability power needs of OEM customers.

From aerospace and defense applications to industrial, safety and security, medical lighting, analytical instrumentation, and clinical diagnostics, Excelitas Technologies is committed to enabling our customers' success in their specialty end-markets. Excelitas Technologies has approximately 3,000 employees in North America, Europe and Asia, serving customers across the world.

www.excelitas.com

Excelitas Technologies

35 Congress Street
Salem, MA 01970 USA
Tel: (+1) 978.745.3200
Toll free: (+1) 800.950.3441
Fax: (+1) 978.745.0894

Excelitas Technologies

LED Solutions
160 E. Marquardt Drive
Wheeling, Illinois 60090 USA
Telephone: (+1) 847.537.4277
Fax: (+1) 847.537.4785

Excelitas Technologies

Lighting & Radiant Sources
44370 Christy Street
Fremont, California 94538
USA
Tel: (+1) 510.979.6500
Toll free: (+1) 800.775.6786
Fax: (+1) 510.687.1140

Excelitas Technologies

Elcos GmbH
Luitpoldstrasse 6
Pfaffenhofen, 85276
Germany
Telephone: (+49) 8441.8917.0
Fax: (+49) 8441.7191.0

Excelitas Technologies

Shenzhen Co., Ltd.
Wearnes Technology Center
No.10 Kefa Road, Science & Industry Park
Nanshan District,
Shenzhen, Guangdong
P.R. of China 518057
Telephone: +86 2655 3861
Fax: +86 755 2661 7311

For a complete listing of our global offices, visit www.excelitas.com/locations

© 2013 Excelitas Technologies Corp. All rights reserved. The Excelitas logo and design are registered trademarks of Excelitas Technologies Corp. All other trademarks not owned by Excelitas Technologies or its subsidiaries that are depicted herein are the property of their respective owners. Excelitas reserves the right to change this document at any time without notice and disclaims liability for editorial, pictorial or typographical errors.

